

東芝照明器具配光データシート

名称	東芝LED器具
形名	LEDT-41201NK-LS9

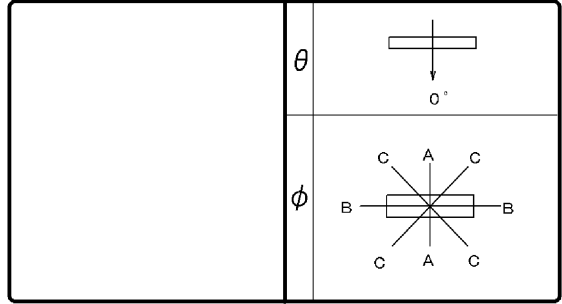

効 率	F	7 %
	F	93 %
	F	100 %
	器具光束	2050 lm

保守率	良	0.83
	中	0.81
	否	0.77

前面	カバー (乳白)
反射面	塗装 (白)

最大取付間隔	
A-A	1.2 H
B-B	1.2 H

備考

光度 (cd/1000lm)			
$\theta \setminus \phi$	A-A	B-B	C-C
0°	310	310	310
10°	294	307	306
20°	279	289	290
30°	256	259	262
40°	225	222	228
50°	188	178	187
60°	148	128	142
70°	106	77	95
80°	69	27	53
90°	43	3	28
100°	31	2	22
110°	28	2	20
120°	26	2	13
130°	18	1	5
140°	6	1	1
150°	1	1	1
160°	1	2	1
170°	1	2	2
180°	1	1	1

反射率 (%)	天井	80			70			50			30		20	0						
	壁	70	50	30	70	50	30	50	30	30	30	10	0							
	床	30	10	30	10	30	10	30	10	30	10	30	10	0						
室指数		固有照明率 (×0.01)																		
0.60	61	56	46	44	38	36	58	54	45	43	37	36	43	41	36	35	35	34	30	27
0.80	72	66	58	54	49	47	70	64	57	53	48	46	54	51	46	45	45	44	39	36
1.00	79	71	65	61	56	53	76	69	64	59	55	52	60	57	53	51	50	49	44	42
1.25	87	77	74	67	64	60	84	75	71	66	62	59	67	63	60	57	57	55	51	48
1.50	92	81	79	72	70	65	88	79	77	70	68	64	72	68	65	62	62	60	55	52
2.00	100	87	89	80	80	73	96	85	86	78	78	72	80	75	74	70	70	67	63	60
2.50	105	91	95	84	87	78	100	88	92	82	84	77	85	79	79	74	75	72	68	65
3.00	109	93	100	87	92	82	104	91	96	85	89	81	89	82	84	78	79	75	71	68
4.00	113	96	106	92	100	87	108	94	102	90	96	86	94	86	90	83	84	80	76	73
5.00	116	98	110	94	104	91	111	96	105	92	100	89	97	89	94	86	87	83	80	76
10.00	122	102	119	100	115	98	117	100	114	98	111	96	104	94	102	93	95	89	87	83

