

東芝照明器具配光データシート

名称	蛍光灯器具
形名	FT-15003-GL 16

保守率	良	0.74
	中	0.70
	否	0.61

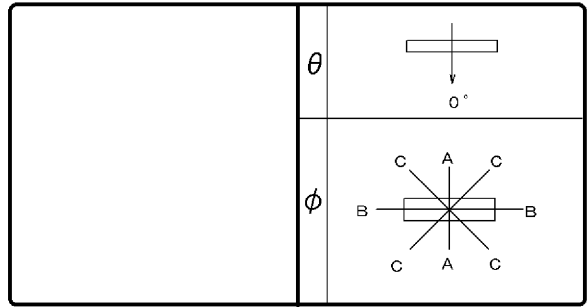

光源	名称	蛍光ランプ
	形名	FL15W
	光束	860 lm × 1

効率	F \cap	29%
	F \cup	66%
	F \bigcirc	95%
	器具光束	810 lm

最大取付間隔	
A-A	1.6 H
B-B	1.3 H

備考	
----	--

前面	
反射面	塗装 (白)

光度 (cd/1000lm)			
$\theta \setminus \phi$	A-A	B-B	C-C
0°	137	137	137
10°	136	136	136
20°	139	128	134
30°	146	116	132
40°	149	99	128
50°	149	79	121
60°	146	57	112
70°	136	35	99
80°	123	16	84
90°	117	6	76
100°	117	5	79
110°	118	5	76
120°	102	5	57
130°	75	5	36
140°	44	5	15
150°	18	5	4
160°	0	0	0
170°	0	0	0
180°	0	0	0

反射率 (%)	天井		80				70				50				30		20	0		
	壁	床	70	50	30	10	70	50	30	10	70	50	30	10	50	30	30	10		
室指数	照明率 (×0.01)																			
0.60	49	46	36	34	27	27	46	43	34	32	26	25	30	29	24	23	21	21	16	13
0.80	59	54	45	42	36	34	55	51	43	40	34	33	38	36	31	30	28	27	22	18
1.00	66	59	52	48	42	40	61	55	49	45	40	38	43	41	36	35	32	31	26	22
1.25	73	65	59	54	49	46	67	61	55	51	47	44	49	46	42	40	37	36	30	26
1.50	77	68	64	58	55	51	72	64	60	55	52	48	53	50	46	44	41	39	34	29
2.00	85	74	73	65	64	58	79	70	69	62	60	56	60	56	53	50	47	45	40	34
2.50	89	77	79	70	70	63	83	73	74	66	66	60	64	59	58	55	51	49	43	38
3.00	93	80	83	73	75	67	86	75	78	69	71	64	68	62	62	58	55	52	46	41
4.00	98	83	90	77	82	72	91	79	84	74	77	69	73	66	68	63	59	56	51	45
5.00	101	85	94	80	87	76	93	81	87	76	82	72	76	69	71	66	62	59	54	47
10.00	107	90	103	87	99	84	99	85	96	83	92	80	83	75	80	73	70	66	61	54

