

東芝照明器具配光データシート

非常灯

名称	非常用蛍光灯併用形 (電池内蔵)
形名	FTC-31803

保守率	0.66
光束換算係数	1.00

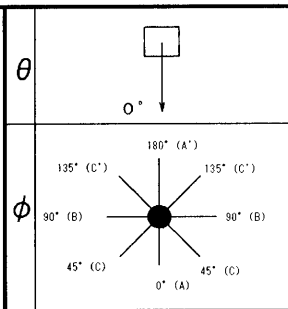
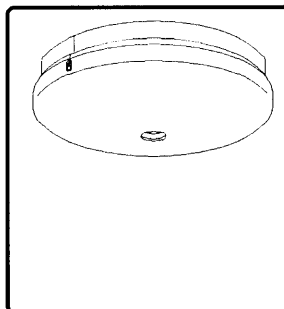

光源	平常時	FCL30W/28 x 1
	非常時	FCL30W/28 x 1
光束	定格	1670 lm
	非常時	668 lm

前面	グローブ (乳白)
反射面	塗装 (白)

備考

取付高さ	2.1	2.4	2.6	3.0	3.5	4.0	4.5	5.0	6.0	7.0
単体配置	A1	2.7	2.7	2.7	2.7	2.6	2.4	2.0	1.3	-
	A'1	2.7	2.7	2.7	2.7	2.6	2.4	2.0	1.3	-
	B1	2.7	2.7	2.7	2.7	2.6	2.4	2.0	1.3	-
	B'1	2.7	2.7	2.7	2.7	2.6	2.4	2.0	1.3	-
直線配置	A2	6.6	6.8	7.0	7.2	7.4	7.4	7.2	7.0	5.8
	B2	6.6	6.8	7.0	7.2	7.4	7.4	7.2	7.0	5.8
四角配置	A4	6.2	6.5	6.7	7.0	7.3	7.4	7.2	7.0	5.8
	B4	6.2	6.5	6.7	7.0	7.3	7.4	7.2	7.0	5.8
壁からの最大取付距離	A0	1.9	1.9	1.9	1.9	1.8	1.8	2.0	2.1	1.9
	A'O	1.9	1.9	1.9	1.9	1.8	1.8	2.0	2.1	1.9
	B0	1.9	1.9	1.9	1.9	1.8	1.8	2.0	2.1	1.9
	B'O	1.9	1.9	1.9	1.9	1.8	1.8	2.0	2.1	1.9

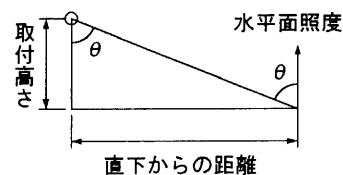
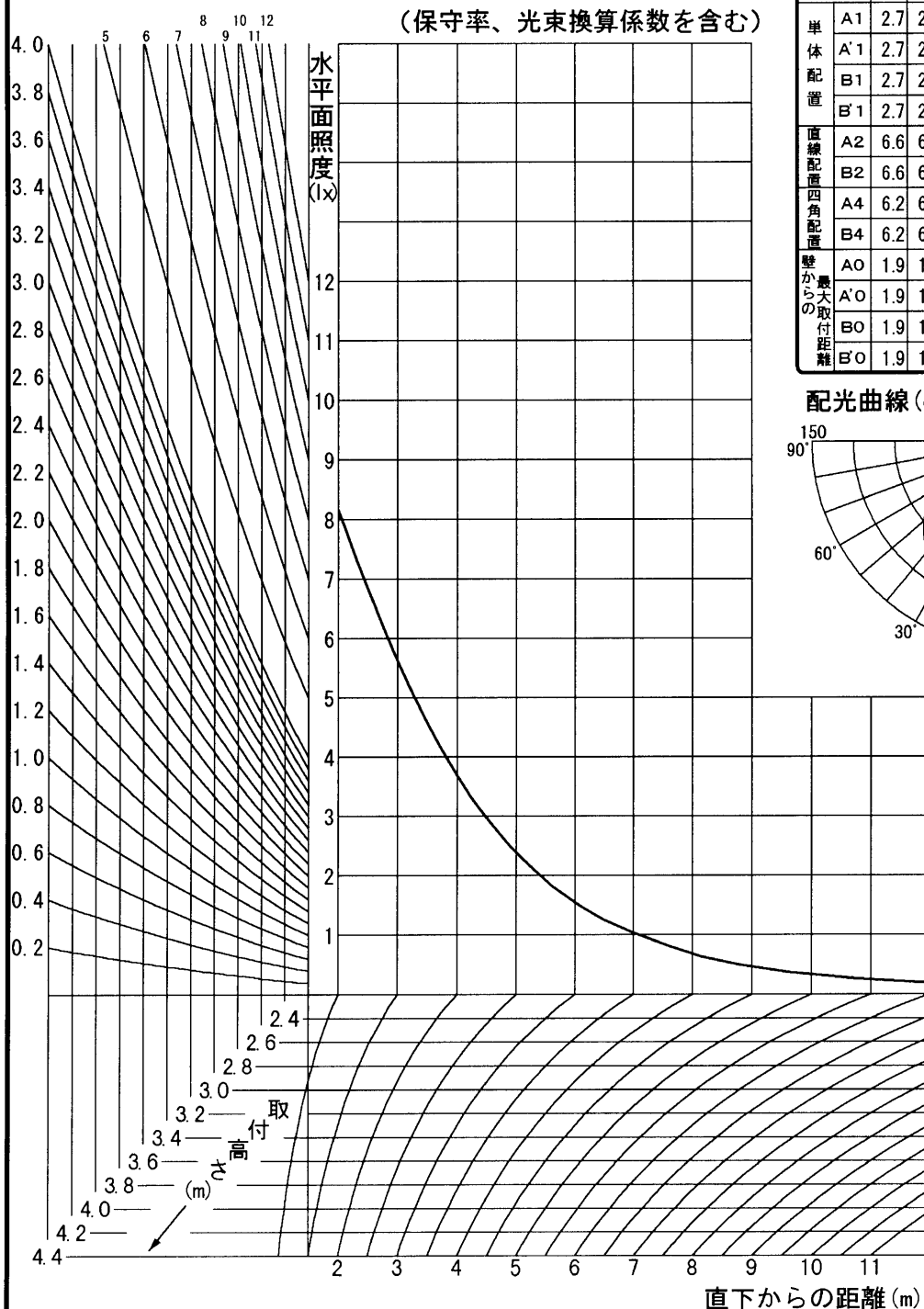
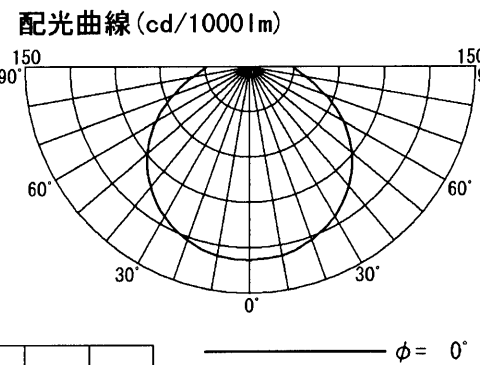

東芝照明器具配光データシート

非常灯

名称	非常用蛍光灯併用形 (電池内蔵)
形名	FTC-31803

保守率	0.66
光束換算係数	1.00

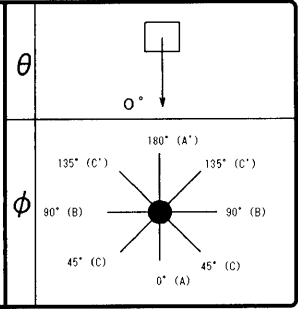
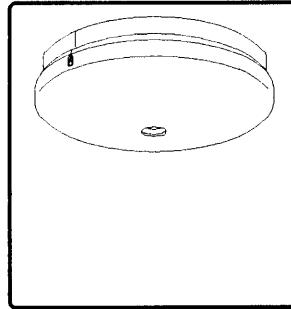

光源	平常時	FCL30W/28 x 1
	非常時	FCL30W/28 x 1
光束	定格	1670 lm
	非常時	668 lm

前面	グローブ (乳白)
反射面	塗装 (白)

備考	
----	--

θ \ φ	0° (A)	45° (C)	90° (B)	135° (C)	180° (A')
0°	128				
10°	127				
20°	122				
30°	114				
40°	103				
50°	89				
60°	72				
70°	54				
80°	38				
90°	29				
100°	28				
110°	25				
120°	19				
130°	0				
140°	0				
150°	0				
160°	0				
170°	0				
180°	0				

取付け高さ (m)	2.1	2.4	2.6	3.0	3.5	4.0	4.5	5.0	6.0	7.0	8.0	10.0	12.0	14.0	16.0
2	0°	2.7	2.7	2.7	2.7	2.6	2.4	2.0	1.3	-	-	-	-	-	-
	45°														
	90°														
	135°														
	180°														
1	0°	3.5	3.6	3.7	3.8	3.9	3.9	3.8	3.6	3.1	2.0	-	-	-	-
	45°														
	90°														
	135°														
	180°														
0.5	0°	4.4	4.6	4.8	5.0	5.2	5.3	5.4	5.5	5.4	5.2	4.7	2.6	-	-
	45°														
	90°														
	135°														
	180°														

東芝照明器具配光データシート

非常灯

名称	非常用蛍光灯併用形 (電池内蔵)
形名	FTC-31803

保守率	0.66
光束換算係数	1.00

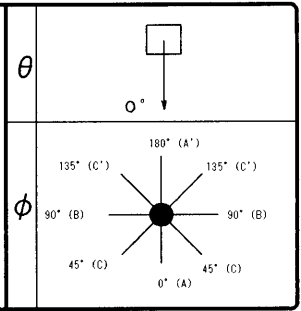
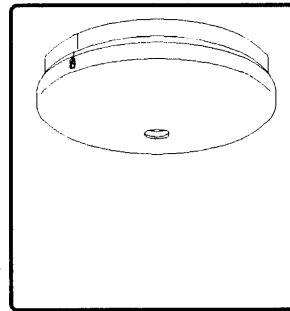

光源	平常時	FCL30W/28 × 1
	非常時	FCL30W/28 × 1
光束	定格	1670 lm
	非常時	668 lm

前面	グローブ (乳白)
反射面	塗装 (白)

備考	
----	--

配置表 (保守率、光束換算係数を含む)

取付高さ		2.1	2.2	2.3	2.4	2.5	2.6	2.7	2.8	2.9	3.0	3.1	3.2	3.3	3.4	3.5	3.6
単体配置	A1	2.7	2.7	2.7	2.7	2.7	2.7	2.7	2.7	2.7	2.7	2.7	2.7	2.7	2.6	2.6	2.6
	A'1	2.7	2.7	2.7	2.7	2.7	2.7	2.7	2.7	2.7	2.7	2.7	2.7	2.7	2.6	2.6	2.6
	B1	2.7	2.7	2.7	2.7	2.7	2.7	2.7	2.7	2.7	2.7	2.7	2.7	2.7	2.6	2.6	2.6
	B'1	2.7	2.7	2.7	2.7	2.7	2.7	2.7	2.7	2.7	2.7	2.7	2.7	2.7	2.6	2.6	2.6
直線配置	A2	6.6	6.8	6.8	6.8	7.0	7.0	7.0	7.2	7.2	7.2	7.2	7.4	7.4	7.4	7.4	7.4
	B2	6.6	6.8	6.8	6.8	7.0	7.0	7.0	7.2	7.2	7.2	7.2	7.4	7.4	7.4	7.4	7.4
四角配置	A4	6.2	6.3	6.4	6.5	6.6	6.7	6.8	6.8	6.9	7.0	7.0	7.1	7.2	7.2	7.3	7.3
	B4	6.2	6.3	6.4	6.5	6.6	6.7	6.8	6.8	6.9	7.0	7.0	7.1	7.2	7.2	7.3	7.3
壁からの最大取付距離	A0	1.9	1.9	1.9	1.9	1.9	1.9	1.9	1.9	1.9	1.9	1.9	1.8	1.9	1.8	1.8	1.7
	A'0	1.9	1.9	1.9	1.9	1.9	1.9	1.9	1.9	1.9	1.9	1.9	1.8	1.9	1.8	1.8	1.7
	B0	1.9	1.9	1.9	1.9	1.9	1.9	1.9	1.9	1.9	1.9	1.9	1.8	1.9	1.8	1.8	1.7
	B'0	1.9	1.9	1.9	1.9	1.9	1.9	1.9	1.9	1.9	1.9	1.9	1.8	1.9	1.8	1.8	1.7

取付高さ		3.7	3.8	3.9	4.0	4.1	4.2	4.3	4.4	4.5	5.0	5.5	6.0	6.5	7.0	7.5	8.0
単体配置	A1	2.5	2.5	2.4	2.4	2.3	2.2	2.1	2.1	2.0	1.3	-	-	-	-	-	-
	A'1	2.5	2.5	2.4	2.4	2.3	2.2	2.1	2.1	2.0	1.3	-	-	-	-	-	-
	B1	2.5	2.5	2.4	2.4	2.3	2.2	2.1	2.1	2.0	1.3	-	-	-	-	-	-
	B'1	2.5	2.5	2.4	2.4	2.3	2.2	2.1	2.1	2.0	1.3	-	-	-	-	-	-
直線配置	A2	7.4	7.4	7.4	7.4	7.4	7.4	7.2	7.2	7.2	7.0	6.4	5.8	4.8	3.2	-	-
	B2	7.4	7.4	7.4	7.4	7.4	7.4	7.2	7.2	7.2	7.0	6.4	5.8	4.8	3.2	-	-
四角配置	A4	7.4	7.4	7.4	7.4	7.4	7.4	7.2	7.2	7.2	7.0	6.4	5.8	4.8	3.2	-	-
	B4	7.4	7.4	7.4	7.4	7.4	7.4	7.2	7.2	7.2	7.0	6.4	5.8	4.8	3.2	-	-
壁からの最大取付距離	A0	1.8	1.8	1.8	1.8	1.8	1.8	2.0	2.0	2.0	2.1	2.0	1.9	2.1	2.7	-	-
	A'0	1.8	1.8	1.8	1.8	1.8	1.8	2.0	2.0	2.0	2.1	2.0	1.9	2.1	2.7	-	-
	B0	1.8	1.8	1.8	1.8	1.8	1.8	2.0	2.0	2.0	2.1	2.0	1.9	2.1	2.7	-	-
	B'0	1.8	1.8	1.8	1.8	1.8	1.8	2.0	2.0	2.0	2.1	2.0	1.9	2.1	2.7	-	-

取付高さ		8.5	9.0	9.5	10.0	10.5	11.0	11.5	12.0	12.5	13.0	13.5	14.0	14.5	15.0	15.5	16.0
単体配置	A1	-	-	-	-	-	-	-	-	-	-	-	-	-	-	-	-
	A'1	-	-	-	-	-	-	-	-	-	-	-	-	-	-	-	-
	B1	-	-	-	-	-	-	-	-	-	-	-	-	-	-	-	-
	B'1	-	-	-	-	-	-	-	-	-	-	-	-	-	-	-	-
直線配置	A2	-	-	-	-	-	-	-	-	-	-	-	-	-	-	-	-
	B2	-	-	-	-	-	-	-	-	-	-	-	-	-	-	-	-
四角配置	A4	-	-	-	-	-	-	-	-	-	-	-	-	-	-	-	-
	B4	-	-	-	-	-	-	-	-	-	-	-	-	-	-	-	-
壁からの最大取付距離	A0	-	-	-	-	-	-	-	-	-	-	-	-	-	-	-	-
	A'0	-	-	-	-	-	-	-	-	-	-	-	-	-	-	-	-
	B0	-	-	-	-	-	-	-	-	-	-	-	-	-	-	-	-
	B'0	-	-	-	-	-	-	-	-	-	-	-	-	-	-	-	-

東芝照明器具配光データシート

非常灯

名称	非常用蛍光灯併用形 (電池内蔵)
形名	FTC-31803

保守率	0.66
光束換算係数	1.00

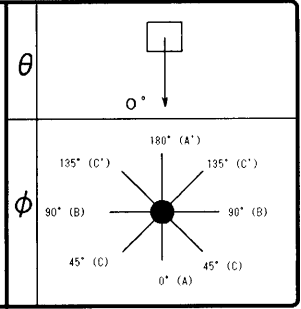
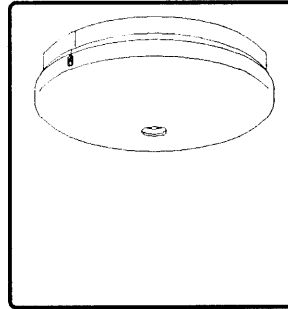

光源	平常時	FCL30W/28 x 1
	非常時	FCL30W/28 x 1
光束	定格	1670 lm
	非常時	668 lm

前面	グローブ (乳白)
反射面	塗装 (白)

備考

器具直下からの各方面への指定照度が得られる距離 (m) (保守率、光束換算係数を含む)

取付け高さ (m)	2.1	2.2	2.3	2.4	2.5	2.6	2.7	2.8	2.9	3.0	3.1	3.2	3.3	3.4	3.5	3.6	
2	0°	2.7	2.7	2.7	2.7	2.7	2.7	2.7	2.7	2.7	2.7	2.7	2.7	2.7	2.6	2.6	2.6
	45°																
	90°																
	135°																
	180°																
1	0°	3.5	3.6	3.6	3.6	3.7	3.7	3.7	3.8	3.8	3.8	3.8	3.9	3.9	3.9	3.9	3.9
	45°																
	90°																
	135°																
	180°																
0.5	0°	4.4	4.5	4.6	4.6	4.7	4.8	4.8	4.9	4.9	5.0	5.0	5.1	5.1	5.1	5.2	5.2
	45°																
	90°																
	135°																
	180°																

取付け高さ (m)	3.7	3.8	3.9	4.0	4.1	4.2	4.3	4.4	4.5	5.0	5.5	6.0	6.5	7.0	7.5	8.0	
2	0°	2.5	2.5	2.4	2.4	2.3	2.2	2.1	2.1	2.0	1.3	-	-	-	-	-	
	45°																
	90°																
	135°																
	180°																
1	0°	3.9	3.9	3.9	3.9	3.9	3.8	3.8	3.8	3.8	3.6	3.4	3.1	2.6	2.0	0.3	-
	45°																
	90°																
	135°																
	180°																
0.5	0°	5.2	5.3	5.3	5.3	5.4	5.4	5.4	5.4	5.4	5.5	5.5	5.4	5.3	5.2	5.0	4.7
	45°																
	90°																
	135°																
	180°																

取付け高さ (m)	8.5	9.0	9.5	10.0	10.5	11.0	11.5	12.0	12.5	13.0	13.5	14.0	14.5	15.0	15.5	16.0
2	0°	-	-	-	-	-	-	-	-	-	-	-	-	-	-	-
	45°															
	90°															
	135°															
	180°															
1	0°	-	-	-	-	-	-	-	-	-	-	-	-	-	-	-
	45°															
	90°															
	135°															
	180°															
0.5	0°	4.4	3.9	3.4	2.6	1.2	-	-	-	-	-	-	-	-	-	-
	45°															
	90°															
	135°															
	180°															