

東芝照明器具配光データシート

非常灯

名称	非常用蛍光灯併用形 (電池内蔵)
形名	FRJ-33701MK

保守率	0.66
光束換算係数	1.00

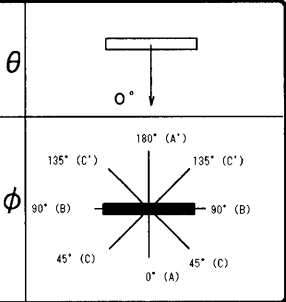
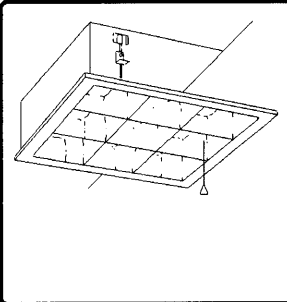

光源	平常時	FPL36EX-N x 3
	非常時	FPL36EX-N x 1
光束	定格	2900 lm
	非常時	725 lm

前面	
反射面	

備考

取付高さ	2.1	2.4	2.6	3.0	3.5	4.0	4.5	5.0	6.0	7.0	
単体配置	A1	2.4	2.6	2.8	3.0	3.3	3.5	3.7	3.8	3.9	3.7
	A'1	2.4	2.6	2.8	3.0	3.3	3.5	3.7	3.8	3.9	3.7
直線配置	B1	2.8	3.0	3.2	3.3	3.5	3.6	3.6	3.6	3.2	2.4
	B'1	2.8	3.0	3.2	3.3	3.5	3.6	3.6	3.6	3.2	2.4
四角配置	A2	5.2	5.6	6.0	6.6	7.4	8.0	8.6	9.2	10.0	10.4
	B2	5.6	6.2	6.6	7.4	8.2	8.8	9.2	9.6	10.2	10.2
壁からの最大取付距離	A0	1.9	2.0	2.1	2.2	2.3	2.5	2.8	2.9	2.9	2.6
	A'O	1.9	2.0	2.1	2.2	2.3	2.5	2.8	2.9	2.9	2.6
	B0	2.1	2.3	2.4	2.5	2.8	3.0	3.1	3.1	3.0	2.5
	B'O	2.1	2.3	2.4	2.5	2.8	3.0	3.1	3.1	3.0	2.5

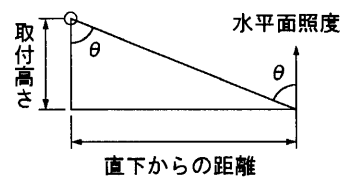
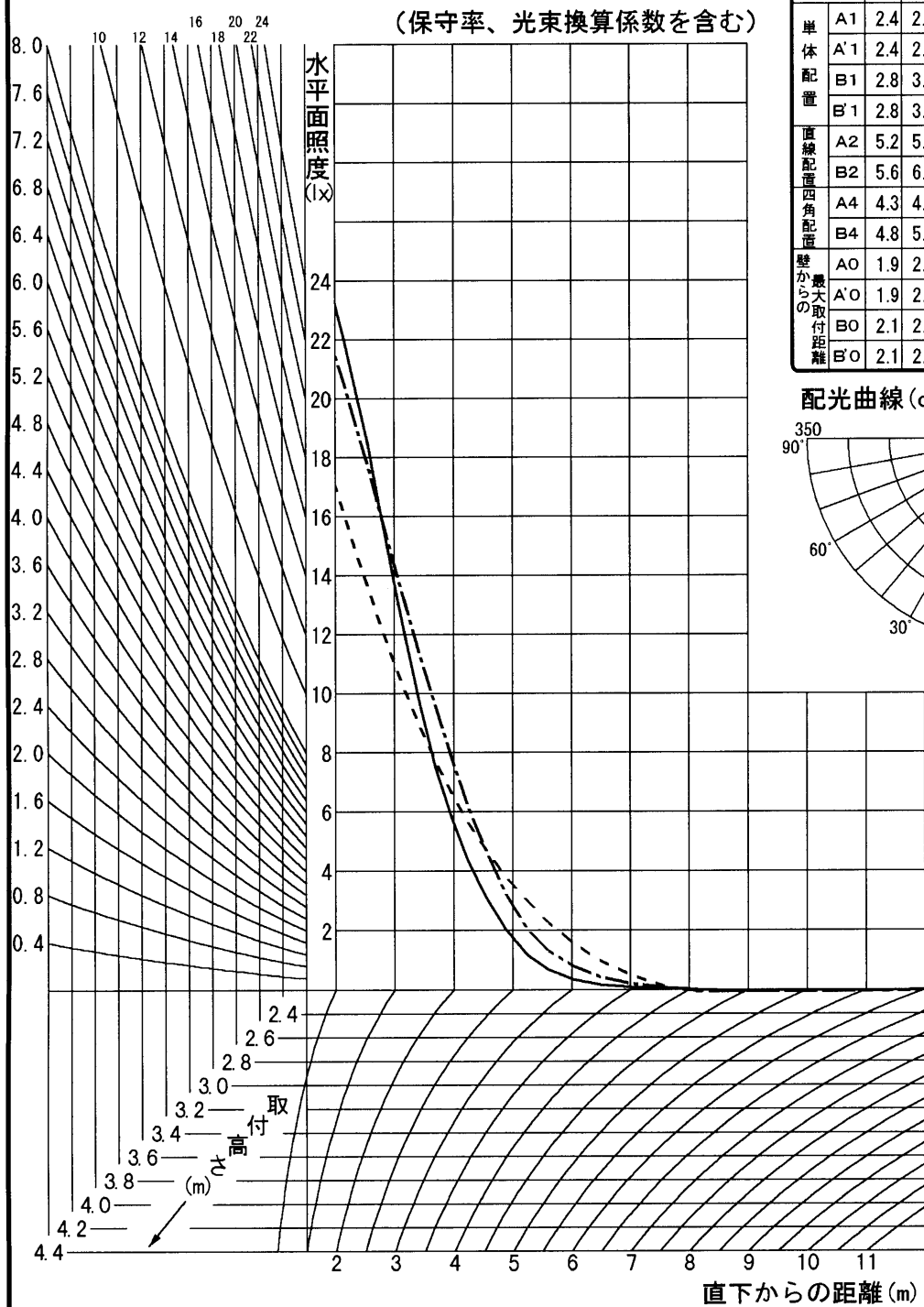
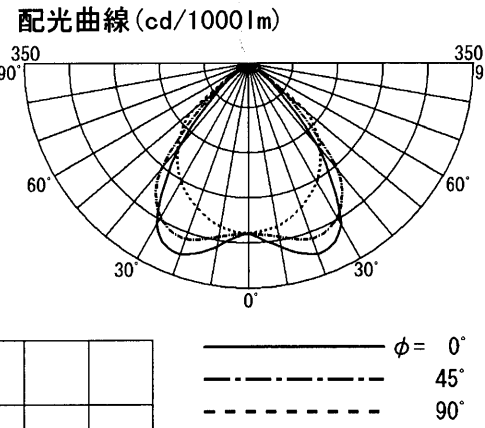

東芝照明器具配光データシート

非常灯

名称	非常用蛍光灯併用形 (電池内蔵)
形名	FRJ-33701MK

保守率	0.66
光束換算係数	1.00

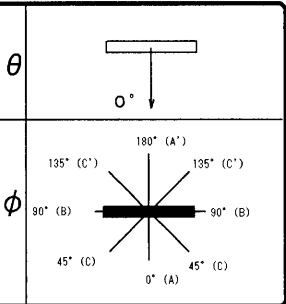
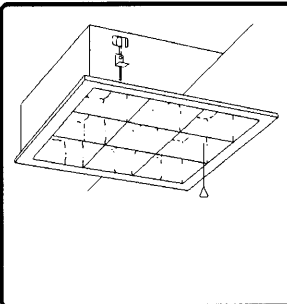

光源	平常時	FPL36EX-N x 3
	非常時	FPL36EX-N x 1
光束	定格	2900 lm
	非常時	725 lm

前面	
反射面	

備考

$\theta \backslash \phi$	0° (A)	45° (C)	90° (B)	135° (C')	180° (A')
0°	264	264	264		
10°	290	274	257		
20°	316	290	239		
30°	289	277	213		
40°	169	216	174		
50°	45	78	115		
60°	7	8	9		
70°	2	1	3		
80°	0	0	0		
90°	0	0	0		
100°	0	0	0		
110°	0	0	0		
120°	0	0	0		
130°	0	0	0		
140°	0	0	0		
150°	0	0	0		
160°	0	0	0		
170°	0	0	0		
180°	0	0	0		

取付け高さ (m)	2.1	2.4	2.6	3.0	3.5	4.0	4.5	5.0	6.0	7.0	8.0	10.0	12.0	14.0	16.0
2	0°	2.4	2.6	2.8	3.0	3.3	3.5	3.7	3.8	3.9	3.7	-	-	-	-
	45°	2.5	2.8	2.9	3.2	3.5	3.8	4.0	4.0	3.9	3.4	-	-	-	-
	90°	2.8	3.0	3.2	3.3	3.5	3.6	3.6	3.6	3.2	2.4	-	-	-	-
	135°														
	180°														
1	0°	2.7	2.9	3.0	3.4	3.8	4.1	4.4	4.7	5.1	5.3	5.5	5.1	-	-
	45°	2.9	3.2	3.4	3.7	4.0	4.4	4.7	5.0	5.5	5.7	5.7	4.7	-	-
	90°	3.1	3.4	3.6	4.0	4.3	4.6	4.8	5.0	5.1	5.0	4.8	3.2	-	-
	135°														
	180°														
0.5	0°	3.0	3.3	3.5	3.8	4.1	4.6	5.0	5.4	6.0	6.6	7.0	7.5	7.8	7.4
	45°	3.2	3.6	3.8	4.2	4.6	5.0	5.4	5.8	6.5	7.0	7.5	8.1	7.9	6.9
	90°	3.4	3.7	4.0	4.4	4.9	5.4	5.8	6.2	6.7	7.0	7.2	7.1	6.4	4.8
	135°														
	180°														

東芝照明器具配光データシート

非常灯

名称	非常用蛍光灯併用形 (電池内蔵)
形名	FRJ-33701MK

保守率	0.66
光束換算係数	1.00

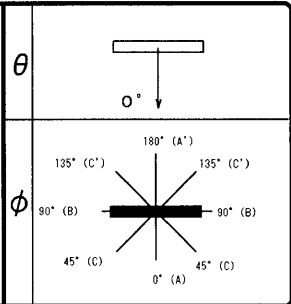
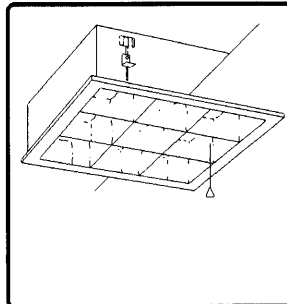

光源	平常時	FPL36EX-N × 3
	非常時	FPL36EX-N × 1
光束	定格	2900 lm
	非常時	725 lm

前面	
反射面	

備考	
----	--

配置表 (保守率、光束換算係数を含む)

取付高さ		2.1	2.2	2.3	2.4	2.5	2.6	2.7	2.8	2.9	3.0	3.1	3.2	3.3	3.4	3.5	3.6
単体配置	A1	2.4	2.5	2.5	2.6	2.7	2.8	2.8	2.9	3.0	3.0	3.1	3.1	3.2	3.2	3.3	3.3
	A'1	2.4	2.5	2.5	2.6	2.7	2.8	2.8	2.9	3.0	3.0	3.1	3.1	3.2	3.2	3.3	3.3
	B1	2.8	2.9	2.9	3.0	3.1	3.2	3.2	3.3	3.3	3.3	3.4	3.4	3.5	3.5	3.5	3.5
	B'1	2.8	2.9	2.9	3.0	3.1	3.2	3.2	3.3	3.3	3.3	3.4	3.4	3.5	3.5	3.5	3.5
直線配置	A2	5.2	5.4	5.4	5.6	5.8	6.0	6.0	6.2	6.4	6.6	6.8	6.8	7.0	7.2	7.4	7.6
	B2	5.6	5.8	6.0	6.2	6.4	6.6	6.8	7.0	7.2	7.4	7.6	7.6	7.8	8.0	8.2	8.2
四角配置	A4	4.3	4.5	4.6	4.7	4.9	5.0	5.1	5.2	5.4	5.5	5.6	5.7	5.9	6.0	6.1	6.3
	B4	4.8	5.0	5.2	5.4	5.5	5.7	5.9	6.1	6.2	6.3	6.5	6.6	6.7	6.8	7.0	7.0
壁からの最大取付距離	A0	1.9	1.9	2.0	2.0	2.1	2.1	2.1	2.1	2.1	2.2	2.2	2.2	2.3	2.3	2.3	2.4
	A'0	1.9	1.9	2.0	2.0	2.1	2.1	2.1	2.1	2.1	2.2	2.2	2.2	2.3	2.3	2.3	2.4
	B0	2.1	2.2	2.2	2.3	2.3	2.4	2.4	2.5	2.5	2.5	2.6	2.6	2.6	2.7	2.8	2.7
	B'0	2.1	2.2	2.2	2.3	2.3	2.4	2.4	2.5	2.5	2.5	2.6	2.6	2.6	2.7	2.8	2.7

取付高さ		3.7	3.8	3.9	4.0	4.1	4.2	4.3	4.4	4.5	5.0	5.5	6.0	6.5	7.0	7.5	8.0
単体配置	A1	3.4	3.4	3.5	3.5	3.5	3.6	3.6	3.6	3.7	3.8	3.9	3.9	3.9	3.7	3.3	-
	A'1	3.4	3.4	3.5	3.5	3.5	3.6	3.6	3.6	3.7	3.8	3.9	3.9	3.9	3.7	3.3	-
	B1	3.5	3.6	3.6	3.6	3.6	3.6	3.6	3.6	3.6	3.6	3.4	3.2	2.9	2.4	1.7	-
	B'1	3.5	3.6	3.6	3.6	3.6	3.6	3.6	3.6	3.6	3.6	3.4	3.2	2.9	2.4	1.7	-
直線配置	A2	7.6	7.8	8.0	8.0	8.2	8.4	8.4	8.6	8.6	9.2	9.6	10.0	10.2	10.4	10.6	10.8
	B2	8.4	8.6	8.6	8.8	8.8	9.0	9.0	9.2	9.2	9.6	10.0	10.2	10.2	10.2	10.0	9.8
四角配置	A4	6.3	6.4	6.6	6.7	6.9	7.0	7.0	7.1	7.2	7.9	8.4	9.0	9.5	10.0	10.5	10.8
	B4	7.2	7.3	7.3	7.5	7.5	7.6	7.7	7.8	7.9	8.3	8.8	9.2	9.5	9.8	10.0	9.8
壁からの最大取付距離	A0	2.4	2.5	2.6	2.5	2.6	2.7	2.7	2.7	2.8	2.9	2.9	2.9	2.9	2.6	2.0	2.0
	A'0	2.4	2.5	2.6	2.5	2.6	2.7	2.7	2.7	2.8	2.9	2.9	2.9	2.9	2.6	2.0	2.0
	B0	2.9	2.9	2.9	3.0	2.9	3.0	3.1	3.1	3.1	3.1	3.2	3.0	2.9	2.5	1.9	1.5
	B'0	2.9	2.9	2.9	3.0	2.9	3.0	3.1	3.1	3.1	3.1	3.2	3.0	2.9	2.5	1.9	1.5

取付高さ		8.5	9.0	9.5	10.0	10.5	11.0	11.5	12.0	12.5	13.0	13.5	14.0	14.5	15.0	15.5	16.0
単体配置	A1	-	-	-	-	-	-	-	-	-	-	-	-	-	-	-	-
	A'1	-	-	-	-	-	-	-	-	-	-	-	-	-	-	-	-
	B1	-	-	-	-	-	-	-	-	-	-	-	-	-	-	-	-
	B'1	-	-	-	-	-	-	-	-	-	-	-	-	-	-	-	-
直線配置	A2	10.8	10.6	10.6	9.8	9.0	7.8	-	-	-	-	-	-	-	-	-	-
	B2	9.4	8.8	8.0	7.2	5.8	3.8	-	-	-	-	-	-	-	-	-	-
四角配置	A4	10.8	10.6	10.6	9.8	9.0	7.8	-	-	-	-	-	-	-	-	-	-
	B4	9.4	8.8	8.0	7.2	5.8	3.8	-	-	-	-	-	-	-	-	-	-
壁からの最大取付距離	A0	2.5	0.2	0.2	1.1	1.9	2.0	-	-	-	-	-	-	-	-	-	-
	A'0	2.5	0.2	0.2	1.1	1.9	2.0	-	-	-	-	-	-	-	-	-	-
	B0	-	0.2	0.2	-	1.3	3.0	-	-	-	-	-	-	-	-	-	-
	B'0	-	0.2	0.2	-	1.3	3.0	-	-	-	-	-	-	-	-	-	-

東芝照明器具配光データシート

非常灯

名称	非常用蛍光灯併用形 (電池内蔵)
形名	FRJ-33701MK

保守率	0.66
光束換算係数	1.00

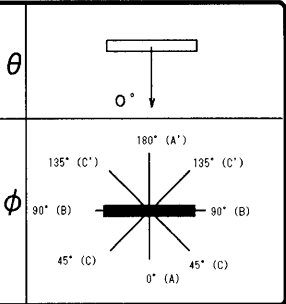
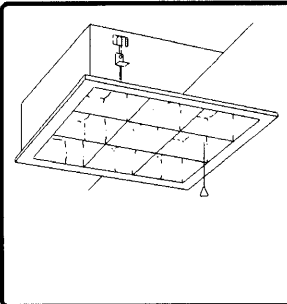

光源	平常時	FPL36EX-N × 3
	非常時	FPL36EX-N × 1
光束	定格	2900 lm
	非常時	725 lm

前面	
反射面	

備考

器具直下からの各方面への指定照度が得られる距離 (m) (保守率、光束換算係数を含む)

取付け高さ (m)	2.1	2.2	2.3	2.4	2.5	2.6	2.7	2.8	2.9	3.0	3.1	3.2	3.3	3.4	3.5	3.6	
2	0°	2.4	2.5	2.5	2.6	2.7	2.8	2.8	2.9	3.0	3.0	3.1	3.1	3.2	3.2	3.3	3.3
	45°	2.5	2.6	2.7	2.8	2.9	2.9	3.0	3.1	3.2	3.2	3.3	3.3	3.4	3.5	3.5	3.6
	90°	2.8	2.9	2.9	3.0	3.1	3.2	3.2	3.3	3.3	3.3	3.4	3.4	3.5	3.5	3.5	3.5
	135°																
	180°																
1	0°	2.7	2.7	2.8	2.9	3.0	3.0	3.1	3.2	3.3	3.4	3.5	3.6	3.6	3.7	3.8	3.8
	45°	2.9	3.0	3.1	3.2	3.3	3.4	3.4	3.5	3.6	3.7	3.7	3.8	3.9	4.0	4.0	4.1
	90°	3.1	3.2	3.3	3.4	3.5	3.6	3.7	3.8	3.9	4.0	4.0	4.1	4.2	4.3	4.3	4.4
	135°																
	180°																
0.5	0°	3.0	3.1	3.2	3.3	3.4	3.5	3.6	3.6	3.7	3.8	3.9	3.9	4.0	4.1	4.1	4.2
	45°	3.2	3.4	3.5	3.6	3.7	3.8	3.9	4.0	4.1	4.2	4.3	4.4	4.5	4.5	4.6	4.7
	90°	3.4	3.5	3.6	3.7	3.9	4.0	4.1	4.2	4.3	4.4	4.5	4.6	4.7	4.8	4.9	5.0
	135°																
	180°																

取付け高さ (m)	3.7	3.8	3.9	4.0	4.1	4.2	4.3	4.4	4.5	5.0	5.5	6.0	6.5	7.0	7.5	8.0	
2	0°	3.4	3.4	3.5	3.5	3.5	3.6	3.6	3.6	3.7	3.8	3.9	3.9	3.9	3.7	3.3	-
	45°	3.6	3.7	3.7	3.8	3.8	3.8	3.9	3.9	4.0	4.0	4.0	3.9	3.8	3.4	2.9	-
	90°	3.5	3.6	3.6	3.6	3.6	3.6	3.6	3.6	3.6	3.6	3.4	3.2	2.9	2.4	1.7	-
	135°																
	180°																
1	0°	3.9	4.0	4.0	4.1	4.2	4.2	4.3	4.3	4.4	4.7	4.9	5.1	5.2	5.3	5.4	5.5
	45°	4.2	4.3	4.3	4.4	4.5	4.5	4.6	4.7	4.7	5.0	5.2	5.5	5.6	5.7	5.7	5.7
	90°	4.5	4.5	4.6	4.6	4.7	4.7	4.8	4.8	4.8	5.0	5.1	5.1	5.1	5.0	4.9	4.8
	135°																
	180°																
0.5	0°	4.3	4.4	4.5	4.6	4.7	4.8	4.8	4.9	5.0	5.4	5.7	6.0	6.3	6.6	6.8	7.0
	45°	4.8	4.9	4.9	5.0	5.1	5.1	5.2	5.3	5.4	5.8	6.1	6.5	6.8	7.0	7.3	7.5
	90°	5.1	5.2	5.3	5.4	5.5	5.6	5.6	5.7	5.8	6.2	6.5	6.7	6.9	7.0	7.1	7.2
	135°																
	180°																

取付け高さ (m)	8.5	9.0	9.5	10.0	10.5	11.0	11.5	12.0	12.5	13.0	13.5	14.0	14.5	15.0	15.5	16.0	
2	0°	-	-	-	-	-	-	-	-	-	-	-	-	-	-	-	
	45°	-	-	-	-	-	-	-	-	-	-	-	-	-	-	-	
	90°	-	-	-	-	-	-	-	-	-	-	-	-	-	-	-	
	135°																
	180°																
1	0°	5.5	5.5	5.5	5.1	4.8	4.3	-	-	-	-	-	-	-	-	-	
	45°	5.6	5.5	5.2	4.7	4.2	3.1	-	-	-	-	-	-	-	-	-	
	90°	4.5	4.2	3.8	3.2	2.5	1.4	-	-	-	-	-	-	-	-	-	
	135°																
	180°																
0.5	0°	7.2	7.3	7.4	7.5	7.6	7.7	7.8	7.8	7.8	7.8	7.7	7.4	7.0	6.6	6.1	-
	45°	7.7	7.9	8.1	8.1	8.1	8.1	8.0	7.9	7.8	7.6	7.3	6.9	6.3	5.8	4.6	-
	90°	7.3	7.2	7.2	7.1	7.0	6.8	6.7	6.4	6.1	5.7	5.3	4.8	4.1	3.3	2.2	-
	135°																
	180°																