

図面番号 DRAWING NO. A-NAF-003

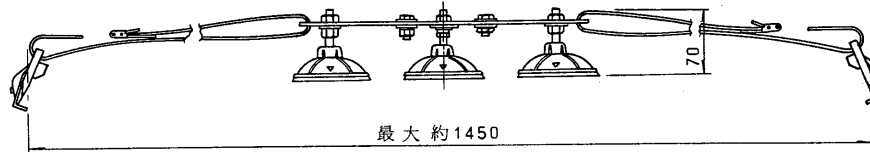

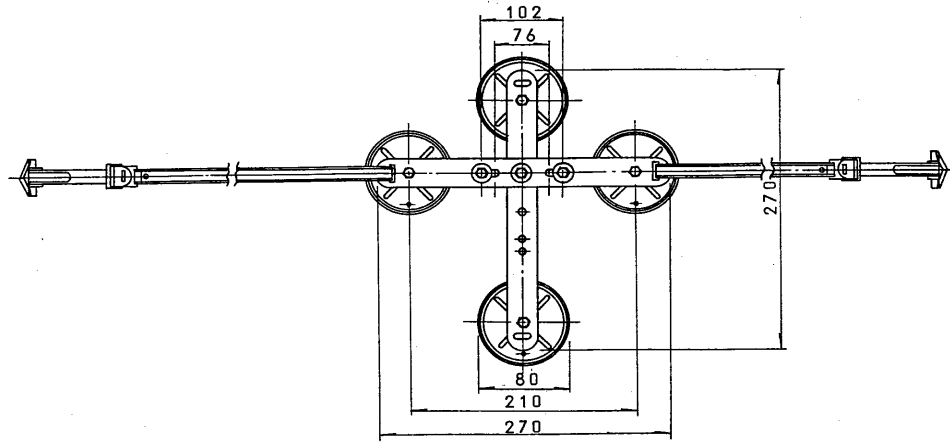

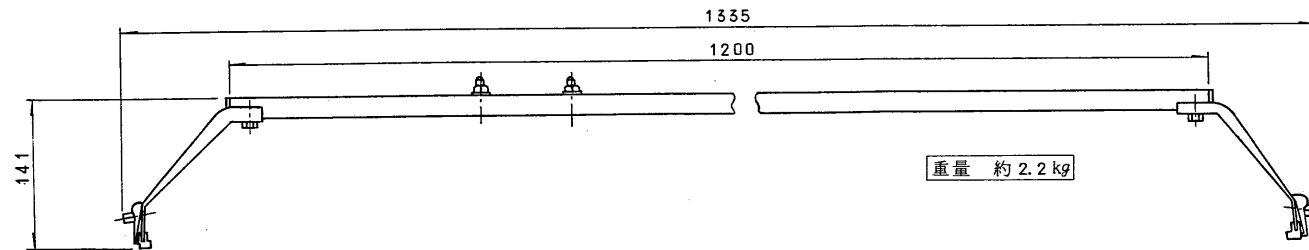
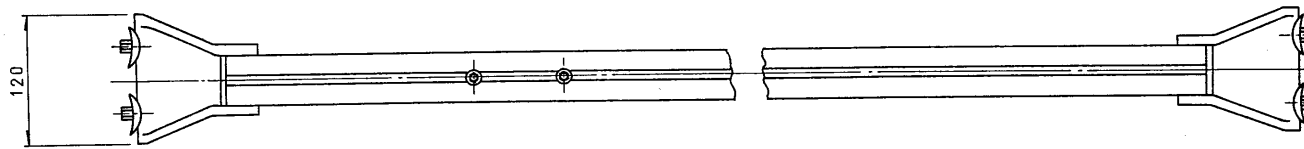

CSC-101

重量 約 1 kg



CSC-102

重量 約 2.2 kg

承認 APPROVED BY 	検図 CHECKED BY 	名称 TITLE スピーカ・キャリア	
設計 DESIGNED BY 	製図 DRAWN BY 	形名 CSC-101, CSC-102	
TOSHIBA  TOKYO JAPAN <b>東芝ライテック株式会社</b> TOSHIBA LIGHTING & TECHNOLOGY CORP.		図面番号 A-NAF-003	第三角法 3RD ANGLE PROJECTION
保管 REGISTERED		尺度 SCALE	単位 UNITS mm