

東芝照明器具配光データシート

名称	東芝LED器具
形名	LEKR414694H N-LS9

保守率	良	0.86
	中	0.81
	否	0.72

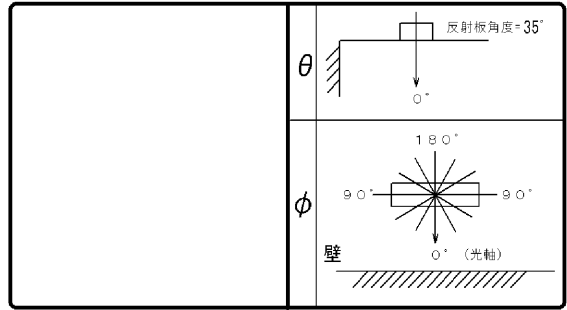

光源	名称	LED
	形名	LEEM-40694N -HGP
	光束	6200 lm x 1

前面
カバー (乳白)
反射面
塗装 (白)

備考

θ \ φ	0°	15°	30°	45°	60°	75°	90°	105°	120°	135°	150°	165°	180°
0°	289			289			289			289			288
10°	337			320			281			254			245
20°	401			355			269			216			203
30°	485			388			246			177			149
40°	505			415			212			125			75
50°	474			387			172			63			57
60°	377			321			126			46			46
70°	152			217			78			33			34
80°	16			32			32			21			21
90°	0			0			1			1			2
100°	0			0			2			0			0
110°	0			0			2			0			0
120°	0			0			1			0			0
130°	0			0			0			0			0
140°	0			0			0			0			0
150°	0			0			0			0			0
160°	0			0			0			1			1
170°	1			1			0			1			1
180°	1			1			1			1			1

