

# 東芝照明器具配光データシート

名称	東芝LED器具
形名	LEKT423321N-LS9

効率	F	5 %
	F	95 %
	F	100 %
	器具光束	3200 lm

保守率	良	0.88
	中	0.86
	否	0.81

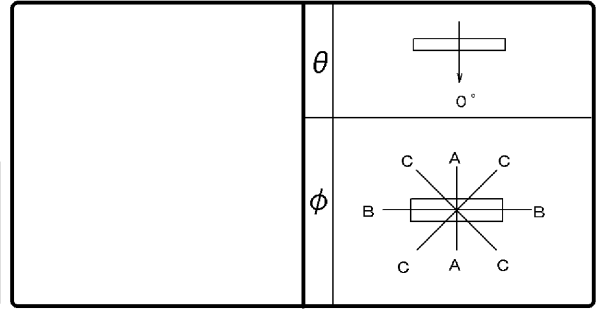

前面	カバー(乳白)
反射面	塗装(白)

最大取付間隔	
A-A	1.27 H
B-B	1.23 H

備考

光度(cd/1000lm)			
θ \ φ	A-A	B-B	C-C
0°	304	304	304
10°	299	298	299
20°	286	281	283
30°	263	253	258
40°	233	218	226
50°	198	176	187
60°	159	129	145
70°	121	79	103
80°	86	30	65
90°	58	2	38
100°	40	1	20
110°	13	1	1
120°	0	1	1
130°	0	1	0
140°	0	0	0
150°	0	0	0
160°	0	0	0
170°	1	0	0
180°	1	1	0

反射率(%)	天井	80						70						50						30		20		0
	壁	70		50		30		70		50		30		50		30		30		10		0		
	床	30	10	30	10	30	10	30	10	30	10	30	10	30	10	30	10	30	10	30	10	10	0	
	室指数	固有照明率(×0.01)																						
	0.60	60	55	46	43	37	36	58	54	45	43	36	35	43	41	35	34	34	34	29	27			
	0.80	72	65	57	54	48	46	69	63	56	53	47	45	53	51	46	44	44	43	38	36			
	1.00	79	71	65	60	55	52	76	69	63	59	54	51	60	57	52	50	50	49	44	42			
	1.25	87	77	73	67	63	59	83	75	71	65	62	58	67	63	59	57	57	55	50	48			
	1.50	92	81	79	71	69	64	88	79	76	70	67	63	72	67	65	61	62	60	55	52			
	2.00	100	87	88	79	79	72	96	85	86	77	77	71	80	75	74	69	70	68	63	60			
	2.50	105	90	94	83	86	77	100	88	91	82	84	76	85	79	79	74	75	72	68	65			
	3.00	108	93	99	87	91	81	104	91	96	85	89	80	89	82	84	78	79	76	72	69			
	4.00	113	96	105	91	99	87	108	94	102	90	96	85	95	86	90	83	85	81	77	74			
	5.00	116	98	109	94	104	90	111	96	105	92	100	89	98	89	94	86	88	84	80	77			
	10.00	122	102	119	100	115	98	117	100	114	98	111	96	105	95	103	93	96	90	88	85			

